



Kingfisher 6 Recreational Tent

Model No. KC072-382

PITCHING INSTRUCTIONS

Your tent includes:

- 29 x steel pegs (5mm D X 178mm L)
- 7 x ropes
- 2 x BLACK fibreglass poles (5700mm x 11mm)
- 2 x GREY fibreglass poles (4890mm x 9.5mm)

1. Select a dry, level site and clear the ground of any sharp objects. Remove the tent from its carry bag, untie fabric ties and unroll the tent.

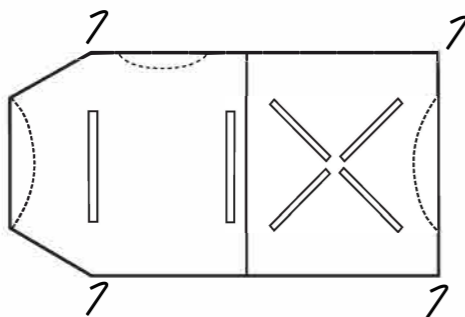

2. Open the pole bag and remove the pegs, the two GREY fibreglass poles and two BLACK fibreglass poles. Assemble these poles now.

- To make sure the tent stays in place, insert the pegs into the ground at a 45° angle.

3. Spread out the floor of the inner tent and peg out the four main corners first, ensuring that the tent is pulled taut and square. Unzip and open the doors to make erecting the tent easier. Pitch the inner so it is in line with the wind, never side on.

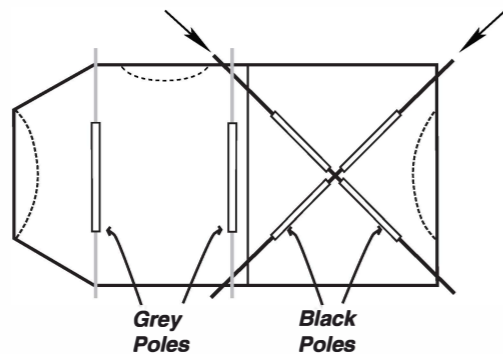

4. Lay out the poles to match the coloured trim on the power mesh pole sleeves. Thread the BLACK poles through the sleeves across the bedroom.

Fit into the pin and ring fittings on the floor and erect the room (this will take 2 people). The bedroom is now up.

5. Moving back to front repeat this for the two remaining GREY poles. Your inner is now erected.

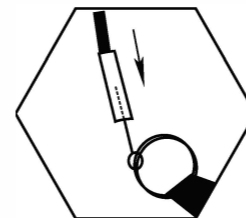

6. Making sure the tent is sitting evenly, attach the speed-clips onto the corresponding poles and peg out the remaining pegging points on the inner.

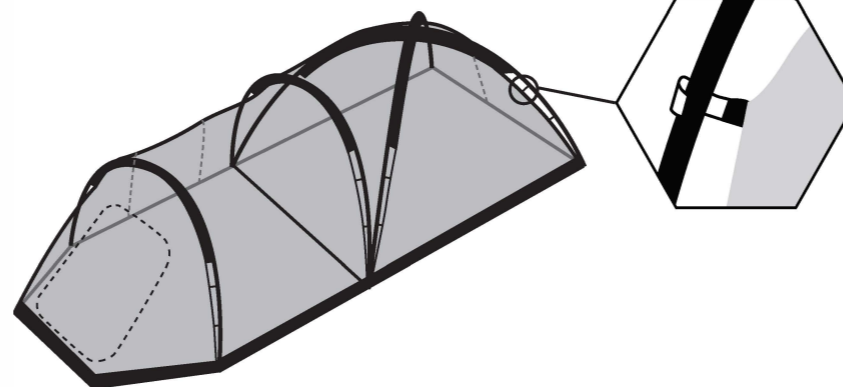

7. Carefully pull the fly over the inner and peg out the 4 corners. Opening all the doors reach under the fly and attach any fabric ties to centralize the fly. This also helps the tent's performance in the wind. Once this is done, zip the doors up and finish pegging out the fly.

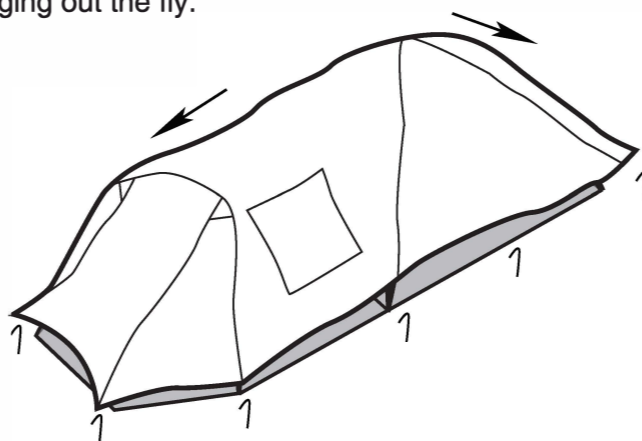

8. Finally, rope out the guy ropes and fine-tune the fly so it remains taut and positioned correctly over the tent.



REVERSE THE PROCEDURE TO LOWER THE TENT

PACKING INSTRUCTIONS

After you have removed the fly, lay it flat inside the tent. This makes it easier to fold the tent. Pack the poles and pegs into their bags. When folding the tent inner, leave all doors and windows open. Fold the inner tent floor from each side to the centre and in half again. Adjust to the length of the poles. Place the poles on the floor and roll them inside so that the floor is on the outside. Store and pack the tent in its bag.

TENT CARE INSTRUCTIONS

PLEASE READ ALL OF THE TENT CARE INFORMATION AND INSTRUCTIONS INCLUDED WITH THIS TENT BEFORE USING YOUR TENT FOR THE FIRST TIME.

1. Before you use your new tent, fully unpack and pitch it at home. It is important to familiarise yourself with the set-up procedure and the various features.
2. Select a site that is level, clear of any sharp objects, is dry, will drain well if it rains and is protected from wind and other elements.
3. Keep clear of overhead power lines and trees when setting up your tent.
4. For best and easiest results, enlist the help of at least one other person to assist in pitching the tent.
5. Keep all flame and heat sources away from this tent fabric. Do not use open flame or gas appliances in or near your tent.
6. Do not use aerosol sprays or any solvent-based products in or around your tent as these could damage the fabric or special coatings. These products include but are not limited to: repellent spray, hair sprays, alcohol, detergents, fly spray, petrol, kerosene etc.
7. Please note, the warranty on this tent will be deemed void if the product is used for any purpose other than a **temporary, recreational** use shelter.
8. Handle the tent poles carefully. When unfolding and folding the tent poles, do not allow the shock cord to pull and snap the ends together. This can damage the poles ends and result in breakage when the pole is tensioned.
9. Especially in windy conditions, it is essential that you attach guy ropes and fasten them to the ground. We suggest you insert the

pegs into the ground at a 45° angle towards the tent, not straight down. Please note, your tent will not be covered under warranty if wind damage occurs.

10. Use all of the guy ropes and pegs included to ensure your tent is secure and to prevent damage to both yourself and the tent. Check guy ropes/pegs daily.
11. Ensure there is an adequate gap between the fly and inner tent to enable ventilation and to prevent condensation build-up.
12. Hold the flaps up, when closing the doors, to take pressure off the zips. Ensure that the tent fabric is never overstretched, especially as this may cause problems with the internal doors.
13. To clean your tent, only ever use a soft sponge and warm water. DO NOT use excessive force or other harsh cleaners to remove marks from the tent.
14. Ensure the tent is completely dry and clean before storing away and ensure to store it in a dry environment.

IMPORTANT:

1. Under certain conditions (cold weather, high humidity etc.) condensation may form on the inside of your tent fly. Condensation can occur for many reasons including vapour from your breath, perspiration, cooking nearby or wet clothing inside your tent. This does NOT mean your tent is leaking through the fabric. You can minimise condensation by opening windows and airing out your tent during the day and by removing any wet clothing/towels etc.
2. Try to avoid pitching your tent under trees as tree limbs, falling leaves, sap, bird droppings or excess water dripping from the trees can cause damage to the tent fabric and its special coatings resulting in leakage or discolouration.

3. Only remove the tent pegs by pulling on the peg itself. NEVER pull on the tent or the shock cords to remove pegs as it could result in damage to the tent or personal injury.
4. DO NOT leave the tent pitched for weeks at a time as extended exposure to the sun's ultraviolet rays can damage and/or cause it to discolour. Your tent will not be covered under warranty if you leave it up for many weeks at a time.
5. STORAGE:
NEVER store your tent wet or dirty (even for short periods of time). NEVER store your pegs or poles inside your tent. Always use the separate bags they are supplied in.
6. You may want to insure your tent against loss or damage.

WARRANTY INFORMATION

The warranty period for this tent is found on the packaging and full details are on the Kiwi Camping website - www.kiwicamping.co.nz.

Key points:

The original purchaser of this product is offered a warranty if during this time period the product fails due to a fault in either materials or workmanship. Service under this warranty is available by returning the product, with your proof of purchase, to where it was purchased. If after inspection it is determined that the product is defective, we will repair or replace it (at our discretion) free of charge. This warranty does not cover misuse, damage caused by accident, storm or wind damage, mildew, neglect, UV degradation and fair wear and tear. Please note, the warranty on this tent will be deemed void if the product is used for any purpose other than a temporary shelter. If the claim is not deemed a warranty or is outside it's warranty period, we can repair the product at a nominal cost.



Distributed by: Aber, Hamilton, NZ
www.kiwicamping.co.nz

5285-06/21