

## **IMPORTANT**

Read these instructions for use carefully. Familiarise yourself with the appliance before connecting it to its gas container. Keep these instructions for future reference.

### **ONLY USE IN WELL-VENTILATED AREAS.**

#### **CARBON MONOXIDE HAZARD!**

THIS APPLIANCE CAN PRODUCE CARBON MONOXIDE WHICH HAS NO ODOUR. USING IT IN AN ENCLOSED SPACE (FOR EXAMPLE, CARAVAN, TENT, CAR, MOBILE HOME) MAY CAUSE DEATH.

- Do not modify this appliance.
- Check that seals between the appliance and the gas container are in place and in good condition before connecting the gas container.
- Do not use the appliance if it has damaged or worn seals.
- Do not use this appliance if it is leaking, damaged or does not operate properly.
- This appliance must only be serviced by an authorized person.
- The openings at the base of the burner provide air for combustion, they should never be obstructed. If the flame becomes significantly orange check these openings for a blockage.
- If the appliance cannot be adjusted to perform correctly it should not be used until serviced or repaired.
- To check that the gas container is filled, when shaken a sloshing sound will be heard.

**CAUTION:** Accessible parts may be very hot. Keep young children away.

### **USE OUTDOORS ONLY.**

#### **BUTANE PRODUCT**

This appliance shall only be used with an 75% butane/25% propane mix gas cartridge certified to EN417 or equivalent.

#### **IT MAY BE HAZARDOUS TO ATTEMPT TO FIT OTHER TYPES OF GAS CONTAINERS.**

Only change the gas cartridge in a well ventilated location, preferably outside, away from people and any source of ignition, such as naked flames, pilot flames, and electric heaters/equipment.

If there is a leak on your appliance (smell of gas) and you cannot stop the gas flow, remove the appliance to a well-ventilated location away from any ignition source. Check for leaks using soapy water. Do not try to detect leaks using a flame.

# Gasmate®

## **Sika Stove** **Model No. GM030-028**

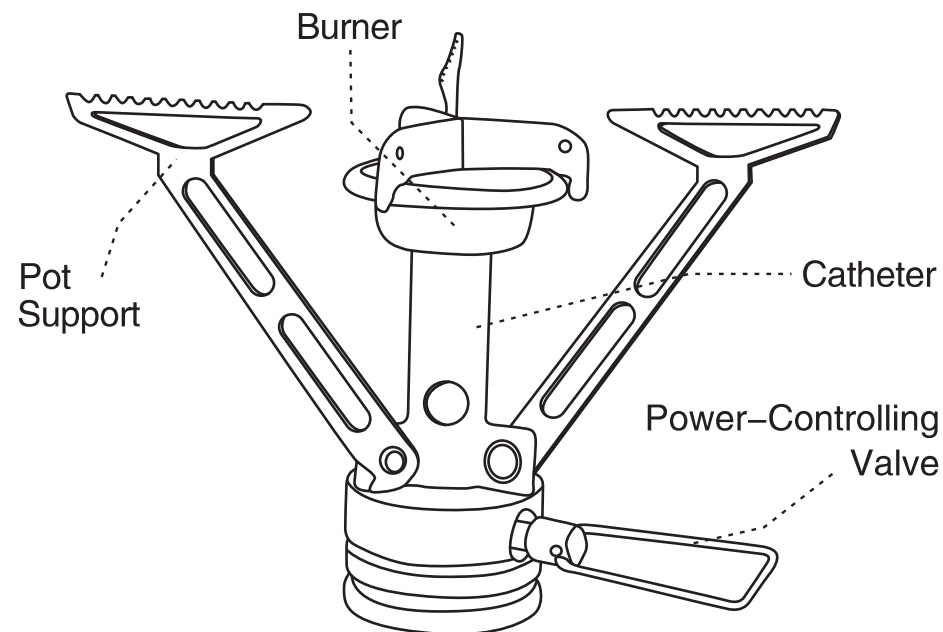

<b>GAS CONSUMPTION</b>	<b>g/h</b>	<b>MJ/h</b>	<b>BTU</b>	<b>Injector Size</b>
<b>GM030-028</b>	230 g/h	11.5 MJ/h	10,900 BTU	0.3mm

Gasmate® is a registered trademark of: Sitro Group Australia Pty Ltd [www.gasmate.com.au](http://www.gasmate.com.au)  
Aber, Hamilton, N.Z. [www.gasmate.co.nz](http://www.gasmate.co.nz)

**Important:** Retain these instructions for future use.

## GENERAL INFORMATION

### INSTRUCTIONS FOR USE

- Remove appliance from carton and remove any transit protection material.
  - The appliance area must be kept clear and free of combustible materials, gasoline and other flammable vapours and liquids.
  - Gas orifices and burner must be kept clear of dirt and cobwebs. Flow of combustion and ventilation air through the perforated portions of the appliance must not be obstructed.
  - Any cleaning agent used on the appliance should be of a non-combustible and non-corrosive nature.
- Proper clearance from combustible materials must be maintained at all times. The minimum clearances are as follows:

#### Minimum Clearance from Combustibles:

**Side** 600mm **Top** 600mm **Rear** 600mm

- Attach the appliance to the specified butane cartridge and ensure that control valve is fully closed and the sealing gasket is firmly sealed against neck of connector. Control valve is suitable for a butane cartridge with a 7/16" - 28NS male thread.
- Place the appliance on a flat horizontal surface and ensure the pot supports have been unfolded.

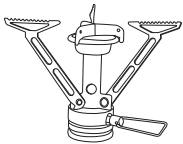

- Turn the flame control switch anti-clockwise gently to allow gas to enter the appliance. Do not open fully.

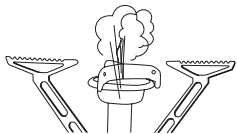

- Ignite by lighting the escaping gas with a match or lighter. Ensure your fingers are lower than the burner rose.

- Use the flame control switch to adjust the level of heat required.

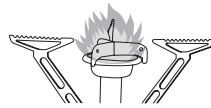

- Twist the flame control switch clockwise to the off position once cooking is complete.

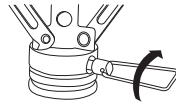

### ANNUAL MAINTENANCE

Clean the body of your appliance using a cotton cloth soaked in soapy hot water. Never use abrasive or flammable cleaning products. Use a soft brush to clean the burner.

### STORAGE

When the appliance is not used it must be stored in its plastic case in a suitable area to protect it from any risk of deterioration. Keep it in a well ventilated area and out of reach of children.

### HANDY HINTS

- Inspect the "O" Ring regularly and replace if worn or damaged.
- Never connect or disconnect the appliance near an open flame.
- Check for gas leaks with SOAPY WATER. DO NOT USE A FLAME.
- Ensure that the area in which the appliance is to be used is well ventilated and DO NOT use as a space heater in tent, caravan, etc.
- Ensure the appliance is completely extinguished before disconnecting from the cartridge.
- Avoid moving the appliance during use as this can cause large flames.
- Allow the appliance to cool down after use before touching the burner or folding the trivets.

## SAFE APPLIANCE LOCATIONS

This appliance shall only be used in an above ground open-air situation with natural ventilation, without stagnant areas, where gas leakage and products of combustion are rapidly dispersed by wind and natural convection.

**Any enclosure in which the appliance is used shall comply with the following:**

An enclosure with walls on all sides, but at least one permanent opening at ground level and no overhead cover (see Example 1).

Within a partial enclosure that includes an overhead cover and no more than two walls (see Example 2 & 3).

**Within a partial enclosure that includes an overhead cover and more than two walls, the following will apply:**

at least 25% of the total wall area is completely open, and at least 30% of the remaining wall area is open and unrestricted (see Example 4 & 5).

**In the case of balconies, at least 20% of the total wall area shall be and remain open and unrestricted.**

## DIAGRAMMATIC REPRESENTATIONS OF OUTDOOR AREAS

The following figures are diagrammatic representations of outdoor areas. Rectangular areas have been used in these figures – the same principles apply to any other shaped area.

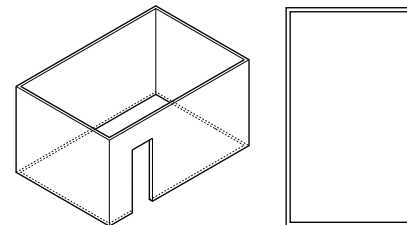

Outdoor Area - Example 1

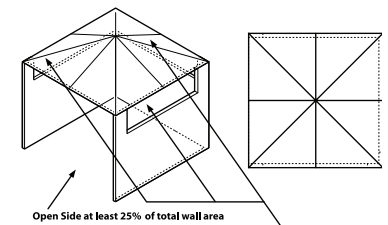

Open Side at least 25% of total wall area  
30% or more in total of the remaining wall area is open and unrestricted

Outdoor Area - Example 4

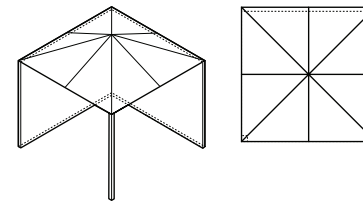

Outdoor Area - Example 2

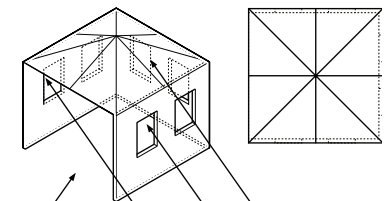

Open Side at least 25% of total wall area  
30% or more in total of the remaining wall area is open and unrestricted

Outdoor Area - Example 5

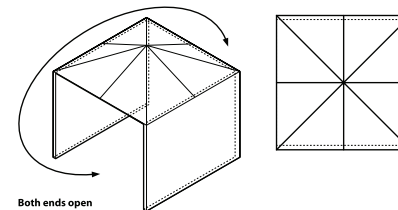

Both ends open

Outdoor Area - Example 3